



Get the most out of your appliance



For quick access to manuals, how-to guides, support and more through our photo registration visit electrolux.com/register



Electrolux

WE'RE THINKING OF YOU

Thank you for purchasing an Electrolux appliance. You've chosen a product that brings with it decades of professional experience and innovation. Ingenious and stylish, it has been designed with you in mind. So whenever you use it, you can be safe in the knowledge that you'll get great results every time.

Welcome to Electrolux.

Visit our website for:



Get usage advice, brochures, trouble shooter, service information:

www.electrolux.com/webselfservice



Register your product for better service:

www.registerelectrolux.com



Buy Accessories, Consumables and Original spare parts for your appliance:

www.electrolux.com/shop

CUSTOMER CARE AND SERVICE

Always use original spare parts.

When contacting our Authorised Service Centre, ensure that you have the following data available: Model, PNC, Serial Number.

The information can be found on the rating plate.

 Warning / Caution-Safety information

 General information and tips

 Environmental information

Subject to change without notice.

CONTENTS

1. SAFETY INFORMATION.....	5
1.1 Children and vulnerable people safety.....	5
1.2 General Safety.....	5
2. SAFETY INSTRUCTIONS.....	8
2.1 Installation.....	8
2.2 Electrical connection.....	9
2.3 Use.....	9
2.4 Care and cleaning.....	10
2.5 Internal lighting.....	10
2.6 Service.....	11
2.7 Disposal.....	11
3. PRODUCT DESCRIPTION.....	12
3.1 General overview.....	12
3.2 Accessories.....	12
4. HOW TO TURN OVEN ON AND OFF.....	13
4.1 Control panel.....	13
4.2 Display.....	13
5. BEFORE FIRST USE.....	16
5.1 Initial Cleaning	16
5.2 First Connection.....	16
5.3 Wireless connection.....	16
5.4 Software Licences.....	17
6. DAILY USE.....	18
6.1 How to set: Heating Functions.....	18
6.2 How to use: Microwave Quick Start	18
6.3 How to set: Assisted Cooking.....	19
6.4 Heating Functions.....	20
7. CLOCK FUNCTIONS.....	23
7.1 Clock functions description.....	23
7.2 How to set: Clock functions.....	23
8. HOW TO USE: ACCESSORIES.....	27
8.1 Inserting accessories.....	27
9. ADDITIONAL FUNCTIONS.....	28
9.1 Automatic Switch-Off.....	28
9.2 Cooling fan.....	28
9.3 Mechanical door lock.....	28
9.4 How to use mechanical door lock.....	29
10. HINTS AND TIPS.....	30
10.1 Cooking recommendations.....	30
10.2 Microwave recommendations	30
10.3 Microwave suitable cookware and materials	30
10.4 Recommended power settings for different kinds of food.....	32
10.5 Cooking tables for test institutes.....	32

CONTENTS

11. CARE AND CLEANING.....	34
11.1 Notes on cleaning.....	34
11.2 How to remove: Shelf supports.....	34
11.3 How to replace: Lamp.....	35
12. TROUBLESHOOTING.....	36
12.1 What to do if.....	36
12.2 How to manage: Error codes.....	37
12.3 Service data.....	38
13. ENERGY EFFICIENCY.....	39
13.1 Energy saving.....	39
14. MENU STRUCTURE.....	40
14.1 Menu.....	40
14.2 Submenu for: Options.....	40
14.3 Submenu for: Connections.....	40
14.4 Submenu for: Setup.....	41
14.5 Submenu for: Service.....	41
15. IT'S EASY!.....	42
16. TAKE A SHORTCUT!.....	44

1. ⚠ SAFETY INFORMATION

Before the installation and use of the appliance, carefully read the supplied instructions. The manufacturer is not responsible for any injuries or damage that are the result of incorrect installation or usage. Always keep the instructions in a safe and accessible location for future reference.

1.1 Children and vulnerable people safety

- This appliance can be used by children aged from 8 years and above and persons with reduced physical, sensory or mental capabilities or lack of experience and knowledge if they have been given supervision or instruction concerning the use of the appliance in a safe way and understand the hazards involved.
- Children between 3 and 8 years of age and persons with very extensive and complex disabilities shall be kept away from the appliance unless continuously supervised.
- Children of less than 3 years of age should be kept away from the appliance unless continuously supervised.
- Do not let children play with the appliance and mobile devices with My Electrolux.
- Keep all packaging away from children and dispose of it appropriately.
- Keep children and pets away from the appliance when it operates or when it cools down. Accessible parts may become hot during use.
- If the appliance has a child safety device, it should be activated.
- Children shall not carry out cleaning and user maintenance of the appliance without supervision.

1.2 General Safety

- Only a qualified person must install this appliance and replace the cable.

SAFETY INFORMATION

- **WARNING:** The appliance and its accessible parts become hot during use. Care should be taken to avoid touching heating elements.
- Always use oven gloves to remove or put in accessories or ovenware.
- Before carrying out any maintenance, disconnect the appliance from the power supply.
- **WARNING:** Ensure that the appliance is switched off before replacing the lamp to avoid the possibility of electric shock.
- Do not use the appliance before installing it in the built-in structure.
- Do not use a steam cleaner to clean the appliance.
- Do not use harsh abrasive cleaners or sharp metal scrapers to clean the glass door since they can scratch the surface, which may result in shattering of the glass.
- If the mains power supply cable is damaged, it must be replaced by the manufacturer, its Authorised Service Centre or similarly qualified persons to avoid an electrical hazard.
- Do not activate the appliance when it is empty. Metal parts inside the cavity can create electric arcing.
- Metallic containers for food and beverages are not allowed during microwave cooking. This requirement is not applicable if the manufacturer specifies size and shape of metallic containers suitable for microwave cooking.
- **WARNING:** If the door or door seals are damaged, the appliance must not be operated until it has been repaired by a qualified person.
- **WARNING:** Only a qualified person can carry out any service or repair operation that involves the removal of a cover which gives protection against exposure to microwave energy.
- **WARNING:** Do not heat liquids and other foods in sealed containers. They are liable to explode.
- Use only utensils that are suitable for use in microwave ovens.

- When heating food in plastic or paper containers, observe the appliance due to the possibility of ignition.
- The appliance is intended for heating food and beverages. Drying of food or clothing and heating of warming pads, slippers, sponges, damp cloth and similar may lead to risk of injury, ignition or fire.
- If smoke is emitted, switch off or unplug the appliance and keep the door closed in order to stifle any flames.
- Microwave heating of beverages can result in delayed eruptive boiling. Care must be taken when handling the container.
- The contents of feeding bottles and baby food jars shall be stirred or shaken and the temperature checked before consumption, in order to avoid burns.
- Eggs in their shell and whole hard-boiled eggs should not be heated in the appliance since they may explode, even after microwave heating has ended.
- The appliance should be cleaned regularly and any food deposits removed.
- Failure to maintain the appliance in a clean condition could lead to deterioration of the surface that could adversely affect the life of the appliance and possibly result in a hazardous situation.

2. SAFETY INSTRUCTIONS

2.1 Installation

 **WARNING!**

Only a qualified person must install this appliance.

- Remove all the packaging.
- Do not install or use a damaged appliance.
- Follow the installation instructions supplied with the appliance.
- Always take care when moving the appliance as it is heavy. Always use safety gloves and enclosed footwear.
- Do not pull the appliance by the handle.
- Install the appliance in a safe and suitable place that meets installation requirements.
- Keep the minimum distance from other appliances and units.
- Before mounting the appliance, check if the oven door opens without restraint.
- The appliance is equipped with an electric cooling system. It must be operated with the electric power supply.
- The built-in unit must meet the stability requirements of DIN 68930.

Cabinet minimum height (Cabinet under the work-top minimum height)	444 (460) mm
Cabinet width	560 mm
Cabinet depth	550 (550) mm
Height of the front of the appliance	455 mm
Height of the back of the appliance	440 mm
Width of the front of the appliance	595 mm
Width of the back of the appliance	559 mm
Depth of the appliance	567 mm
Built in depth of the appliance	546 mm
Depth with open door	882 mm
Ventilation opening minimum size. Opening placed on the bottom rear side	560x20 mm
Mains supply cable length. Cable is placed in the right corner of the back side	1500 mm
Mounting screws	3.5x25 mm

2.2 Electrical connection

WARNING!

Risk of fire and electric shock.

- All electrical connections should be made by a qualified electrician.
- The appliance must be earthed.
- Make sure that the parameters on the rating plate are compatible with the electrical ratings of the mains power supply.
- Always use a correctly installed shockproof socket.
- Do not use multi-plug adapters and extension cables.
- Make sure not to cause damage to the mains plug and to the mains cable. Should the mains cable need to be replaced, this must be carried out by our Authorised Service Centre.
- Do not let mains cables touch or come near the appliance door or the niche below the appliance, especially when it operates or the door is hot.
- The shock protection of live and insulated parts must be fastened in such a way that it cannot be removed without tools.
- Connect the mains plug to the mains socket only at the end of the installation. Make sure that there is access to the mains plug after the installation.
- If the mains socket is loose, do not connect the mains plug.
- Do not pull the mains cable to disconnect the appliance. Always pull the mains plug.
- Use only correct isolation devices: line protecting cut-outs, fuses (screw type fuses removed from the holder), earth leakage trips and contactors.
- The electrical installation must have an isolation device which lets you disconnect the appliance from the mains at all poles. The isolation device must have a contact opening width of minimum 3 mm.
- This appliance is supplied with a main plug and a main cable.

2.3 Use

WARNING!

Risk of injury, burns and electric shock or explosion.

- This appliance is for household use only.
- Do not change the specification of this appliance.
- Make sure that the ventilation openings are not blocked.
- Do not let the appliance stay unattended during operation.
- Deactivate the appliance after each use.
- Be careful when you open the appliance door while the appliance is in operation. Hot air can release.
- Do not operate the appliance with wet hands or when it has contact with water.
- Do not apply pressure on the open door.
- Do not use the appliance as a work surface or as a storage surface.
- Open the appliance door carefully. The use of ingredients with alcohol can cause a mixture of alcohol and air.
- Do not let sparks or open flames to come in contact with the appliance when you open the door.
- Do not put flammable products or items that are wet with flammable products in, near or on the appliance.

SAFETY INSTRUCTIONS

- Do not share your Wi-Fi password.
- Do not use microwave function to preheat the oven.

WARNING!

Risk of damage to the appliance.

- To prevent damage or discoloration to the enamel:
 - do not put aluminium foil directly on the bottom of cavity of the appliance.
 - do not put water directly into the hot appliance.
 - do not keep moist dishes and food in the appliance after you finish the cooking.
 - be careful when you remove or install the accessories.
- Discoloration of the enamel or stainless steel has no effect on the performance of the appliance.
- Use a deep pan for moist cakes. Fruit juices cause stains that can be permanent.
- This appliance is for cooking purposes only. It must not be used for other purposes, for example room heating.
- Always cook with the oven door closed.
- If the appliance is installed behind a furniture panel (e.g. a door) make sure the door is never closed when the appliance operates. Heat and moisture can build up behind a closed furniture panel and cause subsequent damage to the appliance, the housing unit or the floor. Do not close the furniture panel until the appliance has cooled down completely after use.

2.4 Care and cleaning

WARNING!

Risk of injury, fire, or damage to the appliance.

- Before maintenance, deactivate the appliance and disconnect the mains plug from the mains socket.
- Make sure the appliance is cold. There is the risk that the glass panels can break.
- Replace immediately the door glass panels when they are damaged. Contact the Authorised Service Centre.
- Be careful when you remove the door from the appliance. The door is heavy!
- Make sure the cavity and the door are wiped dry after each use. Steam produced during the operation of the appliance condensates on cavity walls and can cause corrosion.
- Clean regularly the appliance to prevent the deterioration of the surface material.
- Fat and food remaining in the appliance can cause fire and electric arcing when the microwave function operates.
- Clean the appliance with a moist soft cloth. Use only neutral detergents. Do not use abrasive products, abrasive cleaning pads, solvents or metal objects.
- If you use an oven spray, follow the safety instructions on its packaging.
- Do not clean the catalytic enamel (if applicable) with detergents.

2.5 Internal lighting

WARNING!

Risk of electric shock.

- The type of light bulb or halogen lamp used for this appliance is for household appliances only. Do not use it for house lighting.

- Before replacing the lamp, disconnect the appliance from the power supply.
- Use only lamps with the same specifications.

2.6 Service

- To repair the appliance contact the Authorised Service Centre.
- Use original spare parts only.

2.7 Disposal



WARNING!

Risk of injury or suffocation.

- Disconnect the appliance from the mains supply.
- Cut off the mains electrical cable close to the appliance and dispose of it.
- Remove the door catch to prevent children or pets from becoming trapped in the appliance.

3. PRODUCT DESCRIPTION

3.1 General overview

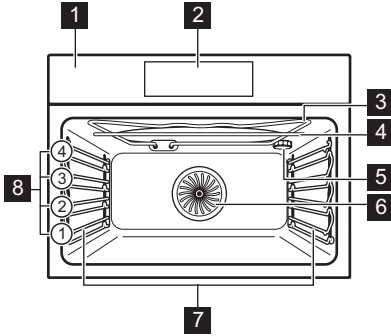

- 1** Control panel
- 2** Display
- 3** Heating element
- 4** Microwave generator
- 5** Lamp
- 6** Fan
- 7** Shelf support, removable
- 8** Shelf positions

3.2 Accessories

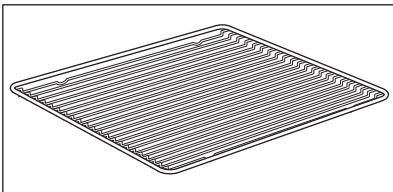

Wire shelf

For cookware, cake tins, roasts.

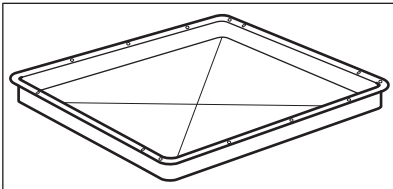

Baking tray

For cakes and biscuits.

4. HOW TO TURN OVEN ON AND OFF

4.1 Control panel

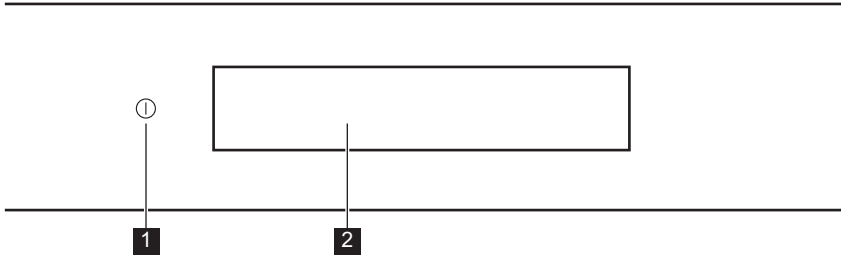

	Function	Comment
1	On / Off	Press and hold to turn the oven on and off.
2	Display	Shows the current settings of the oven.

 Press	 Move	 Press and hold
Touch the surface with fingertip.	Slide fingertip over the surface.	Touch the surface for 3 seconds.

4.2 Display

	After turning on, the display shows the main screen with heating functions and the default temperature.
	If you do not use the oven for 2 minutes, the display goes to standby.
	When you cook, the display shows the set functions and other available options.

HOW TO TURN OVEN ON AND OFF

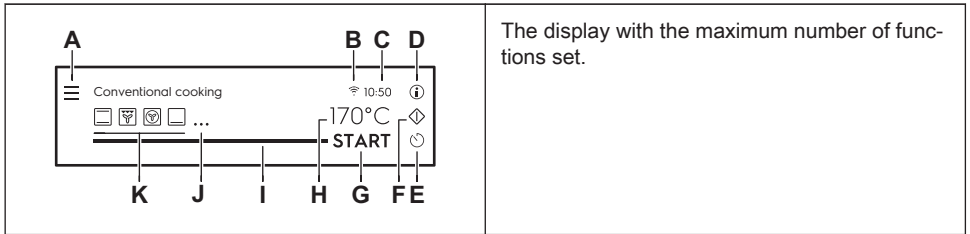

The display with the maximum number of functions set.

- A. Menu / Back
- B. Wi-Fi
- C. Time of Day
- D. Information
- E. Timer
- F. Food Sensor (selected models only)
Microwave Quick Start
- G. START / STOP
- H. Temperature / Microwave Timer
- I. Progress Bar / Slider
- J. More
- K. Heating Functions

Display indicators

Basic indicators - to navigate on the display.









<p>OK To confirm the selection / setting.</p>	<p>< To confirm the selection / setting or to go one level back in the menu.</p>	<p>↶ To go one level back in the menu / undo the last action.</p>	<p>⏻ To turn the options on and off.</p>
---	---	---	--

Sound alarm function indicators - when the set time of cooking ends, the signal sounds.

<p>🔔 The function is on.</p>	<p>🔔 +STOP The function is on. Cooking stops automatically.</p>	<p>🔔 Sound alarm is off.</p>
----------------------------------	---	----------------------------------

Timer indicators

HOW TO TURN OVEN ON AND OFF



Display indicators				
 To set the function: Set Start Time.	 To cancel the setting.	 The timer starts after closing the oven door.	 The timer starts when the oven reaches the set temperature.	 The timer starts when cooking starts.
Door function indicators				
 The oven door is locked.				
Wi-Fi indicators - the oven can be connected to Wi-Fi.				
 Wi-Fi connection is turned on.		 Wi-Fi connection is turned off.		

5. BEFORE FIRST USE

WARNING!

Refer to Safety chapters.

5.1 Initial Cleaning

		
<p>Step 1 Remove all accessories and removable shelf supports from the oven.</p>	<p>Step 2 Clean the oven and the accessories before the first use. Refer to "Care and cleaning" chapter.</p>	<p>Step 3 Put the accessories and the removable shelf supports back to their initial position.</p>

5.2 First Connection

The display shows welcome message after the first connection. You have to set: Language, Display Brightness, Buzzer Volume, Time of Day.

5.3 Wireless connection

To connect the oven you need:

- Wireless network with the Internet connection.

Step 1	Turn on the oven.
Step 2	Press Menu / Settings / Connections.
Step 3	Slide or press  to turn on Wi-Fi.
Step 4	Choose wireless network with the Internet connection. The oven wireless module will start within 90 seconds.

To configure the wireless connection at any other time press  on the display.

Take a shortcut!



Frequency	2412 - 2484 MHz
Protocol	IEEE 802.11b DSSS/802.11g/n OFDM

Max Power	EIRP < 20 dBm (100 mW)
-----------	------------------------

5.4 Software Licences

The oven software contains copyrighted software that is licensed under the BSD, fontconfig, FTL, GPL-2.0, LGPL-2.0, LGPL-2.1, libJpeg, zLib/ libpng, MIT, OpenSSL / SSLEAY ISC, Apache 2.0 and others.

Check the full copy of the licence in: Basic Settings / Service / Licence.

You can download the source code of the open source software by following the hyperlink present on the product web page.

Look for the oven model and Wi-Fi Module Software version on <http://electrolux.opensoftware-repository.com> inside "NIUX" folder.

6. DAILY USE

WARNING!

Refer to Safety chapters.

6.1 How to set: Heating Functions

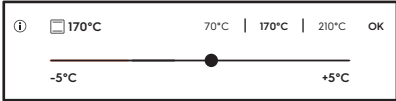
Step 1	Turn on the oven.
Step 2	Select a heating function. The display shows the default heating functions. To see more heating functions press ● ● ● .
Step 3	Press °C. Display goes into the temperature settings. 
Step 4	Move the finger on the slider to set the temperature.
Step 5	Press OK.
Step 6	Press START .
Step 7	Press STOP to turn off the heating function.
Step 8	Turn off the oven.

Take a shortcut!



6.2 How to use: Microwave Quick Start

Step 1	Press and hold  on the display. The microwave runs for 30 seconds.
---------------	---

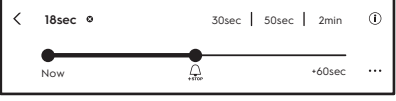

Step 2	To extend the cooking time:	
	<p>Press one of the time shortcuts on the display.</p> 	<p>Press on the running time value to go to the time slider. Move the dot on the time slider to the chosen value.</p> 
<p>The microwave can be switched on with: Microwave Quick Start any time. The only exception: ECO Mode.</p>		

6.3 How to set: Assisted Cooking

Every dish in this submenu has a recommended function and temperature. Temperature and time can be adjusted manually according to the user's preference.

The degree to which a dish is cooked:

- Rare or Less
- Medium
- Well done or More









Step 1	Press  .
Step 2	Press  to enter Assisted Cooking.
Step 3	Choose a dish or food type.
Step 4	Press START .

Take a shortcut!











6.4 Heating Functions

Standard Heating Functions

Heating function	Application
 Grill	To grill thin pieces of food and to toast bread.
 Turbo Grilling	To roast large meat joints or poultry with bones on one shelf position. To make gratins and to brown.
 True Fan Cooking	To bake on up to two shelf positions at the same time and to dry food. Set the temperature 20 - 40 °C lower than for Conventional Cooking.
 Frozen Foods	To make convenience food (e.g., french fries, potato wedges or spring rolls) crispy.
 Conventional Cooking	To bake and roast food on one shelf position.
 Pizza Function	To bake pizza. To make intensive browning and a crispy bottom.
 Bottom Heat	To bake cakes with crispy bottom and to preserve food.
 Microwave	To heat and cook food. The microwave power range is from 100 - 1000 W.







Special Heating Functions

Heating function	Application
 <p>Preserving</p>	To preserve vegetables (e.g. pickles).
 <p>Dehydrating</p>	To dry sliced fruit, vegetables and mushrooms.
 <p>Plate Warming</p>	To preheat plates for serving.
 <p>Dough Proving</p>	To speed up the rising of the yeast dough. It prevents dough surface from drying and keeps the dough elastic.
 <p>Au Gratin</p>	For dishes such as lasagna or potato gratin. To make gratins and to brown.
 <p>Slow Cooking</p>	To prepare tender, succulent roasts.
 <p>Keep Warm</p>	To keep food warm.
 <p>Bread Baking</p>	Use this function to prepare bread and bread rolls with a very good professional-like result in terms of crispiness, colour and crust gloss.

Microwave Oven Functions

Heating function	Application
 <p>Defrost</p>	To defrost meat, fish, fruit, cakes, bread and butter. Power range is 100 - 200 W.

DAILY USE

Heating function	Application
 Reheat	To heat pre-prepared meals and delicate food. Power range is 300 - 700 W.
 Liquid	To heat drinks and soups. Power range is 800 - 1000 W.
 True Fan Cooking + MW	To bake on one shelf position. Function with MW boost.
 Conventional Cooking + MW	To bake and roast food on one shelf position. Function with MW boost.
 Grill + MW	To grill thin pieces of food and to toast bread. Function with MW boost.
 Turbo Grilling + MW	To roast large pieces of meat on one level. To make gratins and to brown. Function with MW boost.



7. CLOCK FUNCTIONS

7.1 Clock functions description

Clock function	Application
Cooking time	To set the length of cooking. Maximum is 23 h 59 min.
Start Criteria	To set when the timer starts counting.
End Criteria	To set what happens when the timer ends counting.
Set Start Time	To postpone the start and / or end of cooking.
Time Extension	To extend cooking time.
Reminder	To set a countdown. Maximum is 23 h 59 min. This function has no effect on the operation of the oven.

Start Criteria, End Action and Delay of cooking are not available for microwave functions.

7.2 How to set: Clock functions

How to set the clock	
Step 1	Press  on the display.
Step 2	Press: Settings / Setup / Time of Day.
Step 3	Slide and press to set the clock.
Step 4	Press OK or  .

How to set cooking time	
Step 1	Choose a heating function and set the temperature.
Step 2	Press  to set the cooking time.
Step 3	Move the dot on the slider or press the preferred time icon.
Step 4	Press OK. Timer starts counting down immediately.

CLOCK FUNCTIONS

Take a shortcut!



How to choose cooking start / end option	
Step 1	Choose a heating function and set the temperature.
Step 2	Press to set cooking time.
Step 3	Press ● ● ● .
Step 4	Press Start Criteria / End Criteria.
Step 5	Choose the preferred Start Criteria / End Criteria.
Step 6	Press OK or <.
Press to cancel chosen starting or end option.	



Start criteria	Comment
-	The timer starts when you turn it on.
	The timer starts after closing the door.
	The timer starts when cooking starts.
	The timer starts when the oven reaches the set temperature.

End action	Comment
	When the set cooking time ends, the signal sounds.
	When the set cooking time ends, the signal sounds. Cooking stops automatically.
	When the set cooking time ends, the display shows the message without a sound signal.

How to delay start and end of cooking	
Step 1	Press  on the display.
Step 2	Move the dot on the slider or press the preferred time icon.
Step 3	Press OK.

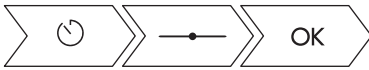
Take a shortcut!





How to delay start without setting the end of cooking	
Step 1	Set a heating function and the temperature.
Step 2	Press  .
Step 3	Press  .
Step 4	Press Set Start Time.
Step 5	Move the left dot to the preferred value.
Step 6	Press OK.

How to set extra time	
When 10% of cooking time is left and the food seems not to be ready, you can extend cooking time. You can also change the oven function.	
Step 1	Press the preferred time icon to extend cooking time.
Step 2	Also, select the preferred heating function to change it.
What if it's better to change extra time?	
It's possible to reset extra time.	

CLOCK FUNCTIONS

How to set extra time	
Step 1	Press  .
Step 2	Move the dot on the slider or press one of the preferred time icons to set the time.
Step 3	Press OK.

How to change timer settings	
Step 1	Move the dot on the slider or use shortcuts to change the timer value.
Step 2	Press OK or press  to reset changes.
You can change the set time during cooking at any time.	

How to cancel set timer	
Step 1	Press  .
Step 2	Press  to cancel set timer.
Step 3	Press OK.

Take a shortcut!



8. HOW TO USE: ACCESSORIES

8.1 Inserting accessories

Use only suitable cookware and material. Refer to "Hints and tips" chapter, Microwave suitable cookware and materials.

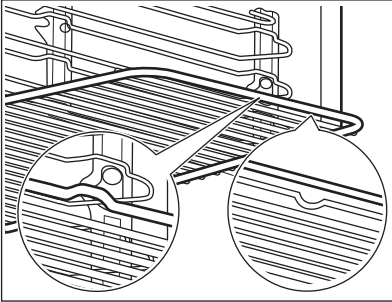
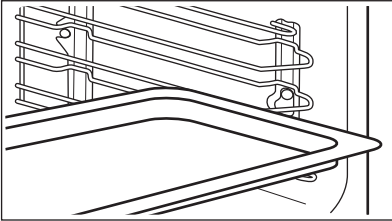
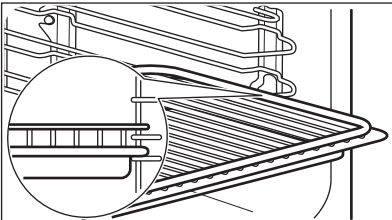

A small indentation at the top increases safety. The indentations are also anti-tip devices. The high rim around the shelf prevents cookware from slipping of the shelf.

<p>Wire shelf:</p>	<p>Push the shelf between the guide bars of the shelf support and make sure that the feet point down.</p> 
<p>Baking tray:</p>	<p>Push the baking tray between the guide bars of the shelf support.</p> 
<p>Wire shelf and baking tray together:</p>	<p>Push the baking tray between the guide bars of the shelf support and the wire shelf on the guide bars above.</p> 

9. ADDITIONAL FUNCTIONS

9.1 Automatic Switch-Off

For safety reasons the oven turns off automatically after some time, if a heating function works and you do not change any settings.

 (°C)	 (h)
30 - 115	12.5
120 - 195	8.5
200 - 230	5.5

The Automatic Switch-off does not work with the functions: Light, End Time, Slow Cooking, .

9.2 Cooling fan

When the oven operates, the cooling fan turns on automatically to keep the surfaces of the oven cool. If you turn off the oven, the cooling fan can continue to operate until the oven cools down.

9.3 Mechanical door lock

The door lock is unlocked when you buy the oven.

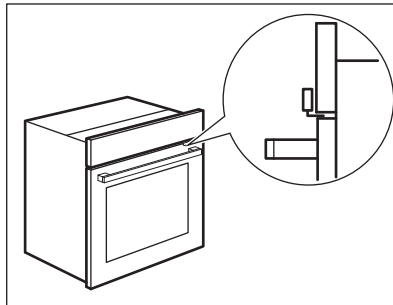

CAUTION!

Do not move the door lock vertically.
Do not push the door lock when you close the oven door.

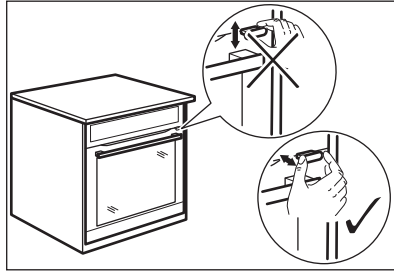

9.4 How to use mechanical door lock

Step 1	To lock the door pull the door lock forward until it locks.
Step 2	To unlock the door push the door lock back into the panel.

Opening the locked door

You can open the door when the door lock is locked.

Step 1 Push the door lock slightly and open the door by pulling it with the handle.

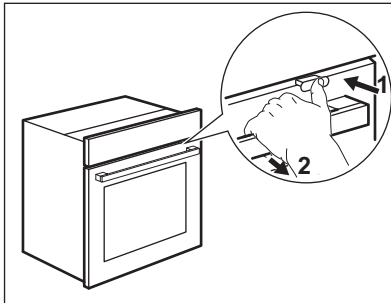

When you close the door make sure that the door lock remains locked.

10. HINTS AND TIPS

WARNING!

Refer to Safety chapters.

10.1 Cooking recommendations

Your oven may bake or roast differently to the oven you had before. The tables below show recommended settings for temperature, cooking time and shelf position for specific types of the food.

If you cannot find the settings for a special recipe, look for the similar one.

For more cooking recommendations refer to cooking tables on our website. To find the Cooking Hints check the PNC number on the rating plate on the front frame of the oven cavity.

10.2 Microwave recommendations

Place the food on a plate on the bottom of the cavity.

Turn or stir the food halfway through the defrosting and cooking time.

Cover the food for cooking and reheating.

Put the spoon to the bottle or glass when heating drinks to ensure better heat distribution.

Put the food into the oven without any packaging. The packaged ready meals can be put into the oven only when the packaging is microwave safe (check information on the packaging).

Microwave cooking

Cook food covered. If you want to keep a crust cook food without a cover.

Do not overcook the dishes by setting the power and time too high. The food can dry out, burn or cause fire.

Do not use the oven to cook eggs or snails in their shells, because they can burst. Pierce the yolk of fried egg before reheating it.

Pierce food with skin or peel with a fork several times before cooking.

Cut vegetables into similar-sized pieces.

Stir liquid dishes from time to time.

Stir the food before serving.

After you turn off the oven, take the food out and let it stand for a few minutes.

Microwave defrosting



Put the frozen, unwrapped food on a small upturned plate with a container below it, or on a defrosting rack or plastic sieve so that the defrosting liquid can run off.



Remove defrosted pieces subsequently.

To cook fruit and vegetables without defrosting them first, you can use a higher microwave power.

10.3 Microwave suitable cookware and materials

For the microwave use only suitable cookware and materials. Use below table as a reference.

















Cookware / Material			
Ovenproof glass and porcelain with no metal components, e.g. heat-proof glass	✓	✓	✓
Non-ovenproof glass and porcelain without any silver, gold, platinum or other metal decorations	✓	X	X

Cookware / Material			
Glass and glass ceramic made of ovenproof / frost-proof material	✓	✓	✓
Ceramic and earthenware without any quartz or metal components and glazes which contain metal	✓	✓	✗
Ceramic, porcelain and earthenware with unglazed bottom or with small holes, e.g. on handles	✗	✗	✗
Heat-resistant plastic up to 200 °C (please always check the plastic container specification before use)	✓	✓	✗
Cardboard, paper	✓	✗	✗
Clingfilm	✓	✗	✗
Roasting film with microwave safe closure (please always check the film specification before use)	✓	✓	✗
Roasting dishes made of metal, e.g. enamel, cast iron	✗	✗	✗
Baking tins, black lacquer or silicon-coated (please always check the baking tins specification before use)	✗	✗	✗
Baking tray	✗	✗	✗
Wire shelf	✗	✗	✓
Cookware for microwave use, e.g. crisp pan	✗	✓	✗

HINTS AND TIPS

10.4 Recommended power settings for different kinds of food





The data in the table is for guidance only.







700 - 1000 W				
 Cooking vegetables	 Searing at the start of the cooking process		 Heating liquids	
500 - 600 W				
 Cooking egg dishes	 Simmering stews	 Heating one-plate meals		 Defrosting and heating frozen meals
300 - 400 W				
 Melting cheese, chocolate, butter	 Simmering rice	 Heating baby food	 Cooking / Heating delicate food	 Continuing cooking
100 - 200 W				
 Defrosting bread	 Defrosting fruit and cakes	 Defrosting cheese, cream, butter		 Defrosting meat, fish

10.5 Cooking tables for test institutes

Information for test institutes

Tests according to IEC 60705.

Use wire shelf unless otherwise specified.					
MICROWAVE FUNCTION	 POWER (W)	 (kg)		 (min)	
Sponge cake	600	0.475	Bottom	7 - 9	Turn container around by 1/4, halfway through the cooking time.
Meatloaf	400	0.9	2	25 - 32	Turn container around by 1/4, halfway through the cooking time.
Egg custard	500	1	Bottom	18	-
Meat defrosting	200	0.5	Bottom	7 - 8	Turn the meat upside down halfway through the cooking time.

Use the wire shelf.						
MICROWAVE COMBI FUNCTION		 POWER (W)	 (°C)		 (min)	
Cake, 0.7 kg	Conventional Cooking + MW	100	200	2	23 - 27	Turn container around by 1/4, halfway through the cooking time.
Potato gratin, 1.1 kg	True Fan Cooking + MW	300	180	2	38 - 42	Turn container around by 1/4, halfway through the cooking time.
Chicken, 1.1 kg	Turbo Grilling + MW	400	230	1	35 - 40	Put the meat in round glass container and turn it upside down halfway through the cooking time.

11. CARE AND CLEANING

⚠ WARNING!

Refer to Safety chapters.

11.1 Notes on cleaning

 Cleaning Agents	Clean the front of the oven with a soft cloth with warm water and a mild cleaning agent.
	To clean metal surfaces, use a dedicated cleaning agent.
	Clean stubborn stains with a special oven cleaner.

 Everyday Use	Clean the oven cavity after each use. Fat accumulation or other food remains may cause fire.
	Dry the cavity with a soft cloth after each use.
	Clean the cavity ceiling carefully from food residuals and fat.

 Accessories	Clean all accessories after each use and let them dry. Use a soft cloth with warm water and a cleaning agent. Do not clean the accessories in a dishwasher.
	Do not clean the non-stick accessories using aggressive agents, sharp-edged objects or in a dishwasher.

11.2 How to remove: Shelf supports

Before maintenance, make sure that the oven is cold. There is a risk of burns. To clean the oven, remove the shelf supports.

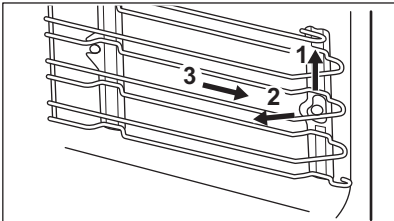
Step 1	 Pull carefully the supports up and out of the front catch.
Step 2	Pull the front end of the shelf support away from the side wall.
Step 3	Pull the supports out of the rear catch.

Install the shelf supports in the opposite sequence.

11.3 How to replace: Lamp

 **WARNING!**

Risk of electric shock.
The lamp can be hot.

Before you replace the lamp:

Step 1	Turn off the oven. Wait until the oven is cold.
Step 2	Disconnect the oven from the mains.
Step 3	Put a cloth on the bottom of the cavity.

 **CAUTION!**

Always hold the halogen lamp with a cloth to prevent grease residue from burning on the lamp.

The top lamp

Step 1	Turn the lamp glass cover to remove it.
Step 2	Clean the glass cover.
Step 3	Replace the lamp with a suitable 300 °C heat-resistant lamp.
Step 4	Install the glass cover.

12. TROUBLESHOOTING

WARNING!

Refer to Safety chapters.

12.1 What to do if...



The oven does not turn on or does not heat up



Possible cause



Remedy

The oven is not connected to an electrical supply or it is connected incorrectly.

Check if the oven is correctly connected to the electrical supply.

The clock is not set.

Set the clock, for details refer to "Clock Functions" chapter, How to set: Clock functions.

The door is not closed correctly.

Fully close the door.

The fuse is blown.

Make sure the fuse is the cause of the problem. If the problem recurs, contact a qualified electrician.

The oven Child Lock is on.

Refer to "Menu" chapter, Submenu for: Options.



Components need to be replaced



Description



Remedy

The lamp is burnt out.

Replace the lamp, for details refer to "Care and Cleaning" chapter, How to replace: Lamp.



Problems with Wi-Fi signal





Possible cause



Remedy

Trouble with wireless network signal.



Check your wireless network and router. Restart the router.

 Problems with Wi-Fi signal	
 Possible cause	 Remedy
New router installed or router configuration changed.	To configure oven and mobile device again, refer to "Before first use" chapter, Wireless connection.
The wireless network signal is weak.	Move router as close to the oven as possible.
The wireless signal is disrupted by a microwave appliance placed near the oven.	Turn off the microwave appliance.



12.2 How to manage: Error codes

When the software error occurs, the display shows error message.



In this section, you will find the list of the problems that you can handle on your own.

 Code and description	 Action
F240, F439 - the touch fields on the display do not work properly.	Clean the surface of the display. Make sure there is no dirt on the touch fields.
F601 - there is a problem with Wi-Fi signal.	Check your network connection. Refer to "Before first use" chapter, Wireless connection.
F604 - the first connection to Wi-Fi failed.	Turn the oven off and on and try again. Refer to "Before first use" chapter, Wireless connection.
F908 - the oven system cannot connect with the control panel.	Turn the oven off and on.

In this section, you will find the list of the problems that have to be handled by a qualified technician.

 Code and description	 Action
F131 - the temperature of magnetron sensor is too high.	Turn the oven off and wait until it cools down. Turn the oven on again.

TROUBLESHOOTING

 Code and description	 Action
F602, F603 - Wi-Fi is not available.	Turn the oven off and on.

When one of these error messages continues to appear on the display, it means a faulty subsystem may have been disabled. In such a case contact your dealer or an Authorized Service Centre. If one of these errors occurs, the rest of the oven functions will continue to work as usually.

12.3 Service data

If you cannot find a solution to the problem yourself, contact your dealer or an Authorized Service Centre.

The necessary data for the service centre is on the rating plate. The rating plate is on the front frame of the oven cavity. Do not remove the rating plate from the oven cavity.

We recommend that you write the data here:	
Model (MOD.)
Product number (PNC)
Serial number (S.N.)

13. ENERGY EFFICIENCY

13.1 Energy saving



The oven contains features which help you save energy during everyday cooking.

Make sure that the oven door is closed properly when the oven operates. Do not open the door too often during cooking. Keep the door gasket clean and make sure it is well fixed in its position.

Use metal cookware to improve energy saving (only when you use a non-microwave function). When possible, do not preheat the oven before cooking.

Keep breaks between baking as short as possible when you prepare a few dishes at one time.

Cooking with fan

When possible, use the cooking functions with fan to save energy.

Residual heat

If a programme with the Duration or End Time selection is activated and the cooking time is longer than 30 minutes, the heating elements automatically turn off earlier in some oven functions.

The fan and lamp continue to operate. When you turn off the oven, the display shows the residual heat. You can use that heat to keep the food warm.

When the cooking duration is longer than 30 minutes, reduce the oven temperature to minimum 3 - 10 minutes before the end of cooking. The residual heat inside the oven will continue to cook.

Use the residual heat to warm up other dishes.

Keep food warm

Choose the lowest possible temperature setting to use residual heat and keep a meal warm.

The residual heat indicator or temperature appears on the display.

Cooking with the lamp off

Turn off the lamp during cooking. Turn it on only when you need it.

Standby mode

After 2 minutes the display goes to standby mode.

14. MENU STRUCTURE

14.1 Menu

Press  to open Menu.

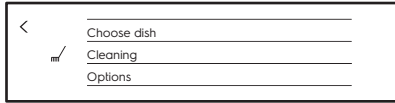

Menu item		Application
Assisted Cooking		Lists automatic programmes.
Options		To set the oven configuration.
Settings	Connections	To set the network configuration.
	Setup	To set the oven configuration.
	Service	Shows the software version and configuration.

14.2 Submenu for: Options

Submenu	Application
Light	To turn the lamp on and off.
Lamp Icon Visible	Lamp icon appears on the screen.
Fast Heat Up	Shortens heat up time. Note that it is available only for some of the oven functions.
Child Lock	Prevents accidental activation of the oven. When the option is on, the text "Child Lock" appears on the display when you turn on the oven. To enable the oven use, choose the code letters in the alphabetical order.
ECO Mode	Switches off Wi-Fi and the display to save as much power as possible. Microwave quickstart is not available on stand-by in ECO Mode .

14.3 Submenu for: Connections

Submenu	Description
Wi-Fi	To enable and disable Wi-Fi.

Submenu	Description
Network	To check network status and Wi-Fi signal power.
Forget Network	To disable current network from auto connection with the oven.

14.4 Submenu for: Setup

Submenu	Description
Language	Sets the oven language.
Time of Day	Sets the current time and date.
Time Indication	Turns the clock on and off.
Digital Clock Style	Changes the format of the displayed time indication.
Key Tones	Turns the tone of the touch fields on and off. It is not possible to switch off the tone of the ON / OFF and STOP.
Alarm / Error Tones	Turns the alarm tones on and off .
Buzzer Volume	Regulates the volume of key tones and signals.
Display Brightness	Regulates the display brightness.

14.5 Submenu for: Service







Submenu	Description
Demo mode	Activation / deactivation code: 2468
Licence	Information about licenses.
Software Version	Information about software version.
Reset All Settings	Restores factory settings.
Reset all popups	Restores all pop-ups to the original settings.

15. IT'S EASY!





Before first use you have to set:

Language	Display Brightness	Buzzer Volume	Time of Day	Wireless connection
----------	--------------------	---------------	-------------	---------------------





Familiarize yourself with the basic icons on the control panel and the display:

 On / Off	 Menu / Back	 Wi-Fi	 Information	 Timer	START / STOP	 More
---	--	--	--	--	--------------	--

Start using the oven



Quick start	Turn on the oven and start cooking with the default temperature and time of the function.	Step 1	Step 2	Step 3
		Press and hold  .	Set the oven function  ...	Press START.
Quick Off	Turn off the oven at any time, any screen or message.	Press and hold  until the oven turns off.		
Quick MW	Start Microwave at any time with the default settings: 30 sec / 1000W.	Press  .		





Start cooking

Step 1	Step 2	Step 3	Step 4	Step 5	Step 6
 Turn on the oven.	 ... Press the function.	 Press to go to the temperature settings.	 Move the finger on the slider to set the temperature.	OK Press to confirm.	START Press to start cooking.

Get to know how to cook quickly

Use the automatic programmes to prepare a dish quickly with the default settings:

Get to know how to cook quickly			
Assisted Cooking	Step 1	Step 2	Step 3
	Press  .	Press  Assisted Cooking.	Choose the dish.

Use quick functions to set the cooking time or change the cooking function		
Quick timer settings Use the most used timer settings by choosing from the shortcuts.	Step 1	Step 2
	Press  .	Press the preferred timer value.
10% Finish assist Use 10% Finish assist to add extra time or change cooking function when 10% of the cooking time is left.	To extend the cooking time press the preferred time icon: +1 min +5 min +10 min .	
	Change function: Press preferred function    ...	

16. TAKE A SHORTCUT!

Here you can see all the useful shortcuts. You can also find them in the dedicated chapters in the user manual.

Wireless connection



How to set: Oven Functions



How to set: Assisted Cooking



How to set cooking time





How to delay start and end of cooking



How to cancel set timer



17. ENVIRONMENTAL CONCERNS

Recycle materials with the symbol . Put the packaging in relevant containers to recycle it. Help protect the environment and human health by recycling waste of electrical and electronic appliances. Do not dispose of appliances marked with the symbol  with the household waste. Return the product to your local recycling facility or contact your municipal office.

www.electrolux.com/shop



867352404-D-352019

